



COMPOSITE FENCING INSTALLATION GUIDANCE

VEEJOY OUTDOOR INDUSTRY LIMITED

www.veejoyoutdoor.com

Please read these instructions carefully before installation. We recommend that you understand in detail the relevant laws and regulations in your area before installing your composite fencing. These installation instructions are intended to provide instructions for proper installation only and are not a substitute for legal and professional permission. The installation and use of our products must be in accordance with the relevant laws and regulations of the region in which they are installed. All risks and responsibilities associated with the installation are the responsibility of the user.

Tools Needed

Standard woodworking tools may be used. Below are tools which might be used for installing Veejoy Outdoor composite fencing.

- Circular saw
- Cordless Drill/Screw driver
- Impact Drill
- Spirit level/Tape/Pencil

Safety



WARNING

When working on any construction project, you should wear protective clothing and safety equipment. Wear face shield, hearing protection, gloves, and long sleeves, particularly when cutting in confined spaces.

Components of composite fencing



△ Post Mounting Base

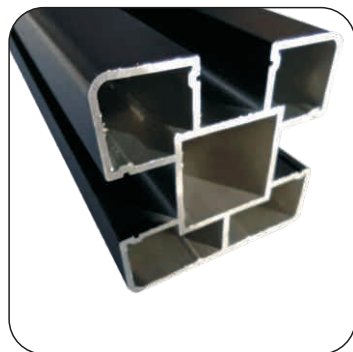

△ Aluminium Post

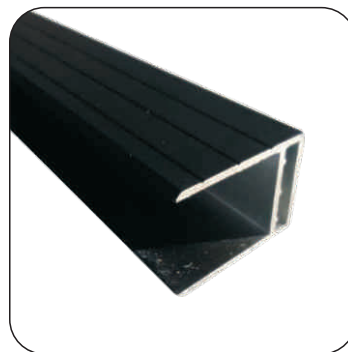

△ Top/Bottom Beam



△ Aluminium Post Cover

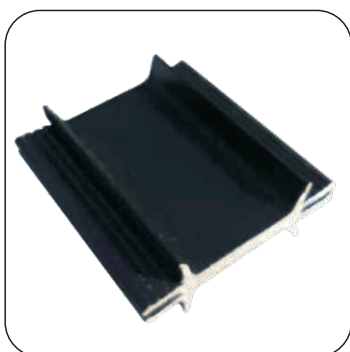

△ Aluminium Spacer



△ Angle Bracket

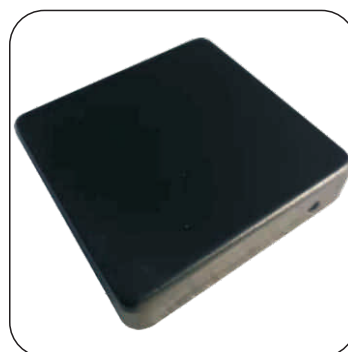

△ Aluminium Post Caps



△ Expansion Bolts

3 Styles of Composite Fencing we can build with Veejoy Outdoor Composite Fencing system

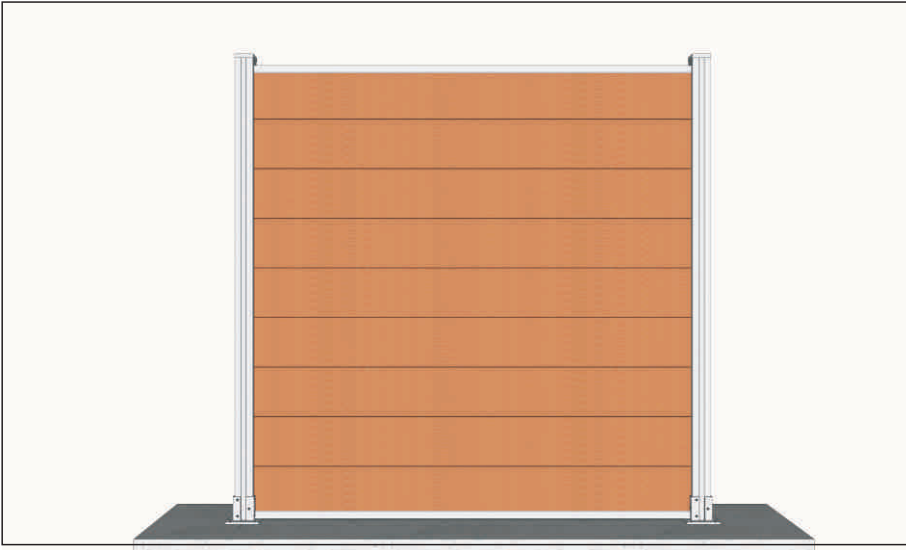

Private Fencing

Half Private Fencing

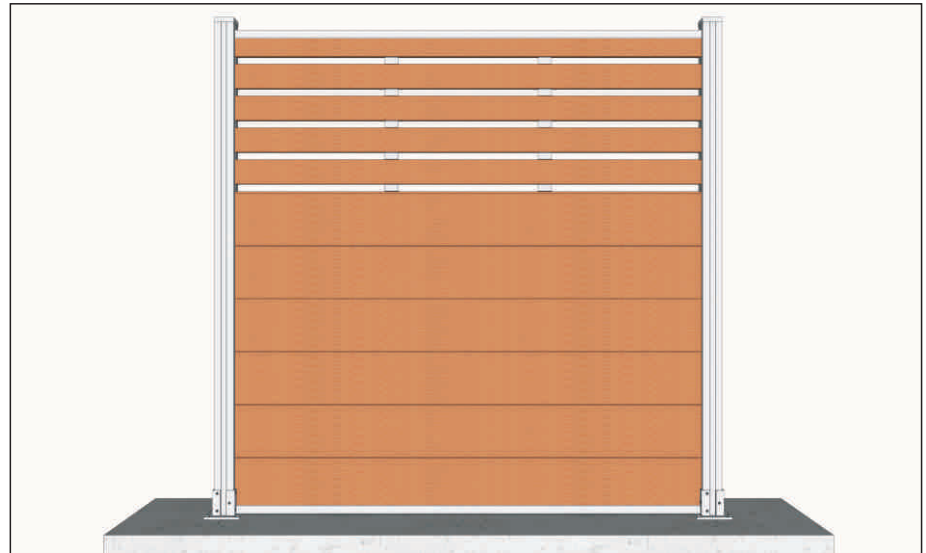

Opening Fencing

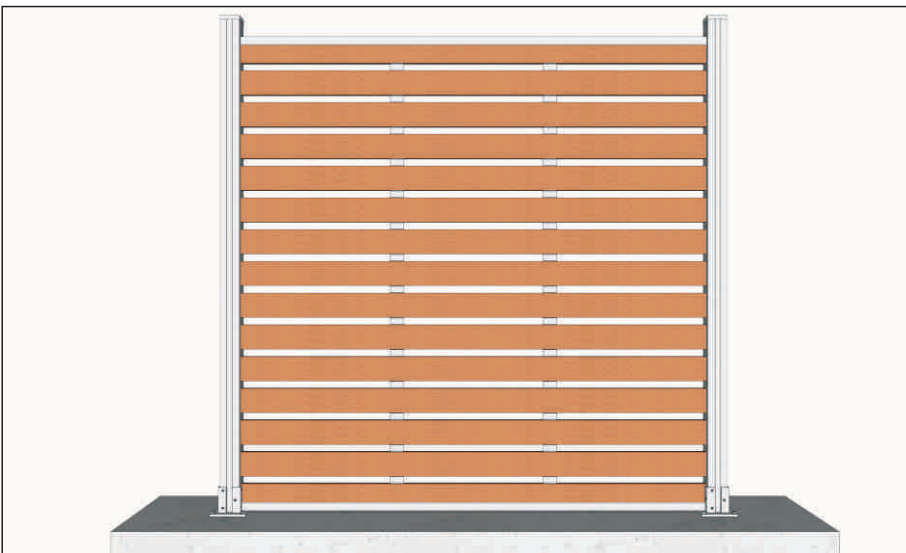

1

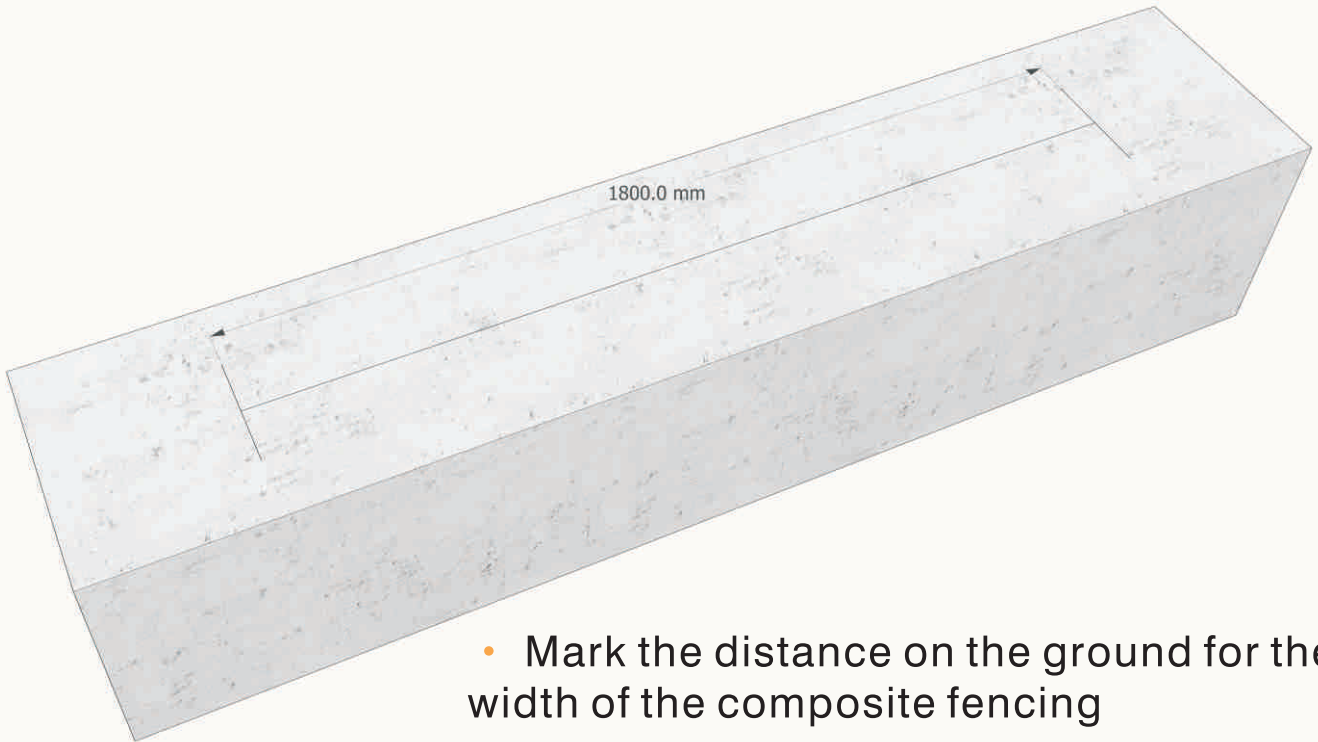

- Mark the distance on the ground for the width of the composite fencing

2

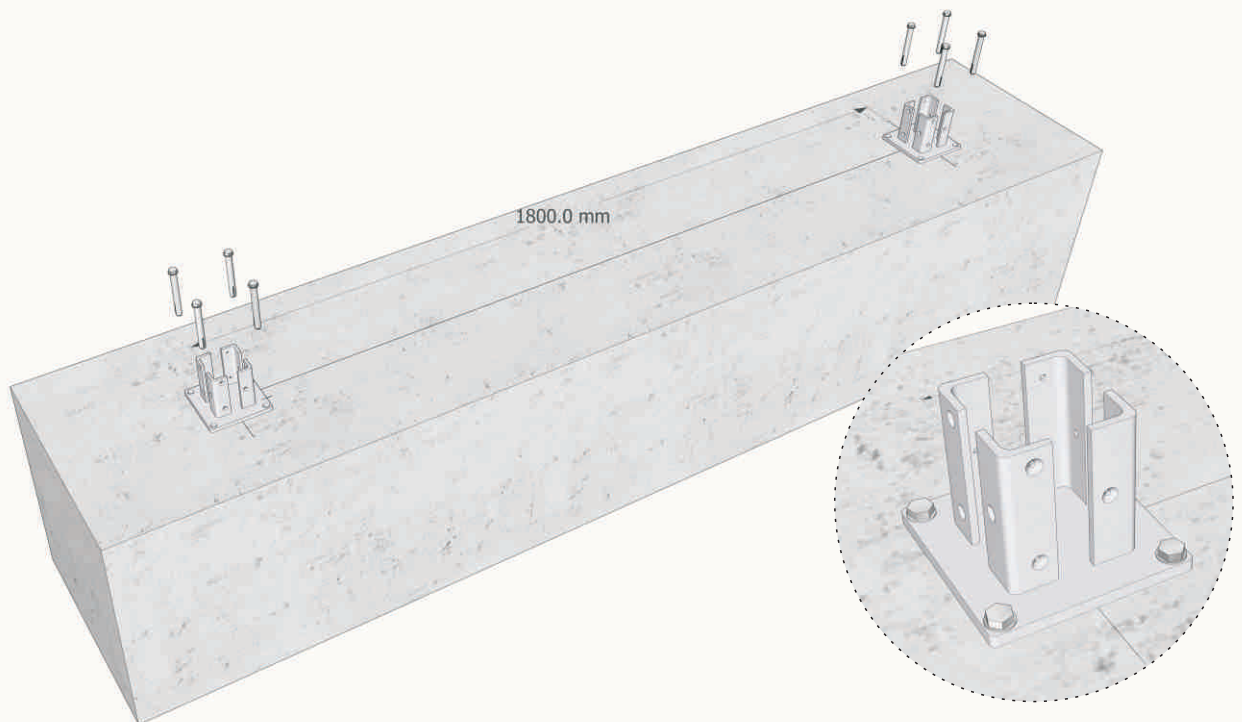

- Place the post mounting base centrally on the marked line, drill the holes according to the holes on the mounting base and install the expansion bolts.

3

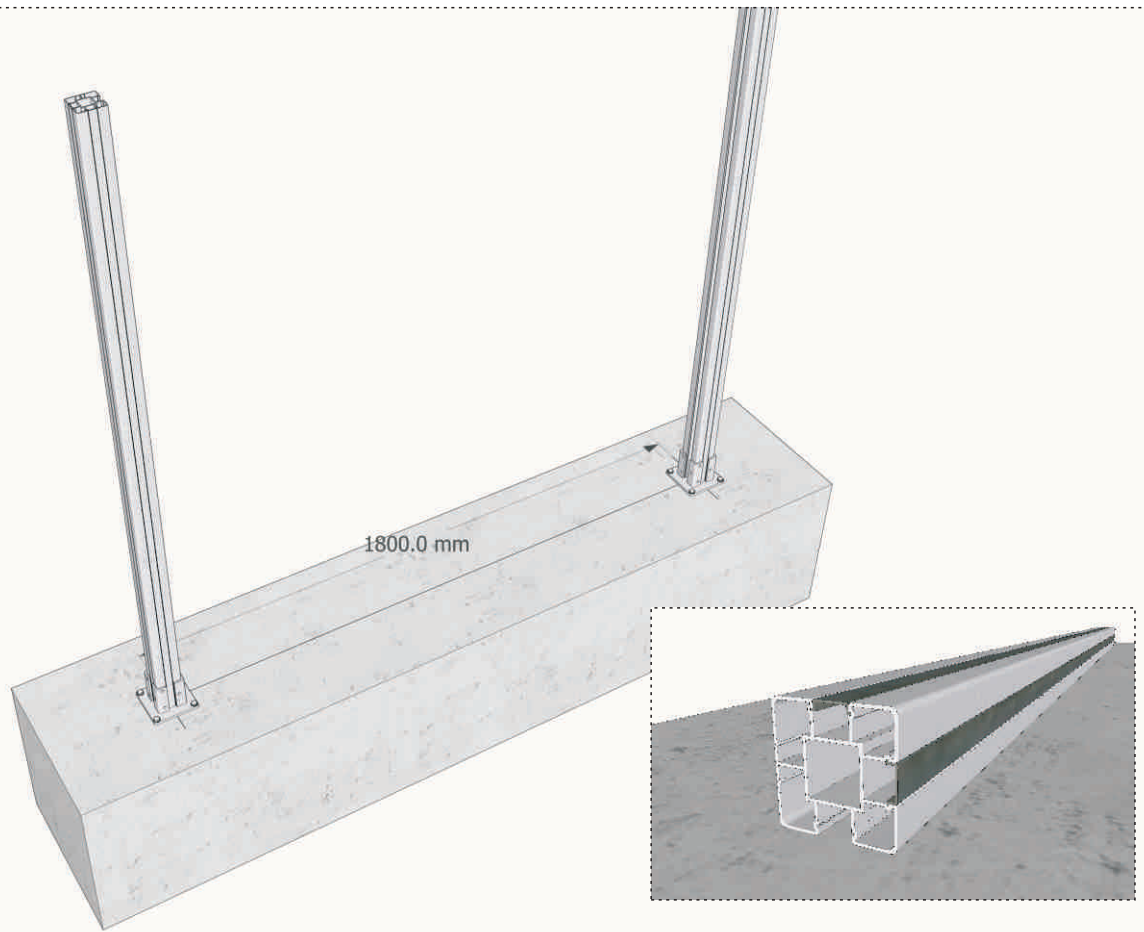

- Insert the post cover into the post firstly and place it into the mounting base.

4

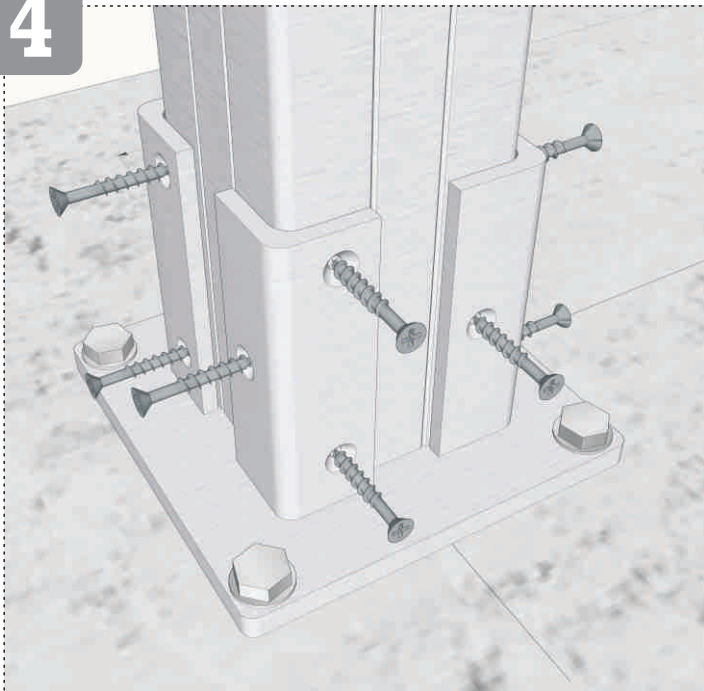

5

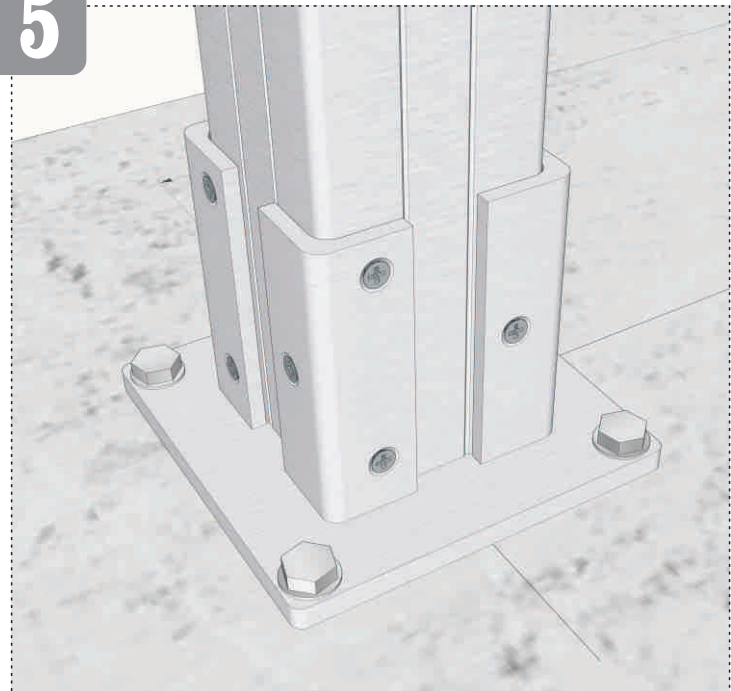

- Use self-drilling screws to fix the post in the mounting base.

6

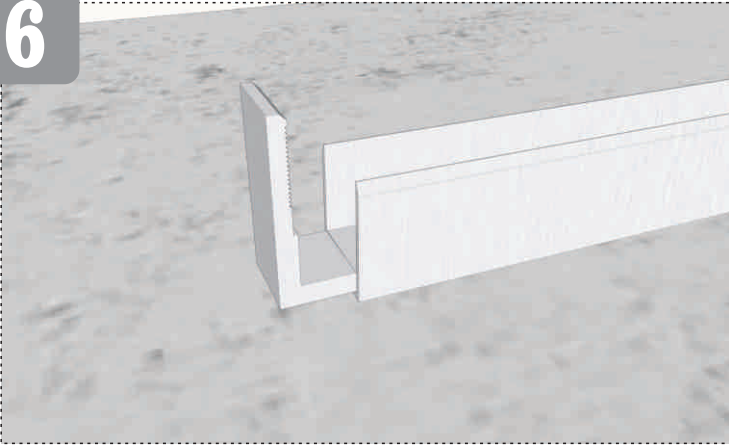

7

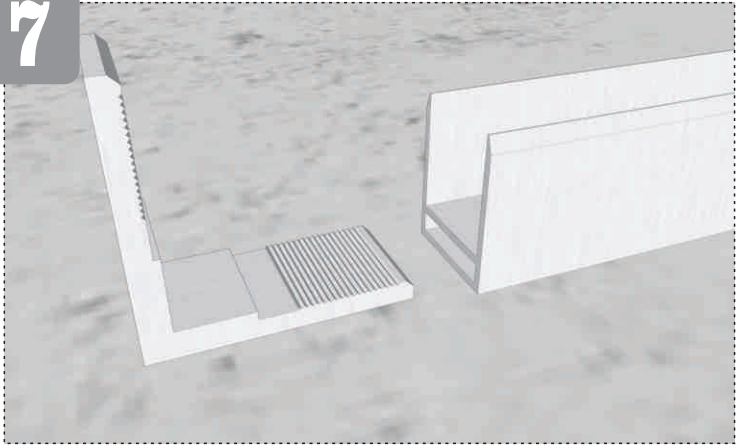

- Put the angle bracket into the bottom beam as above picture showed.

8

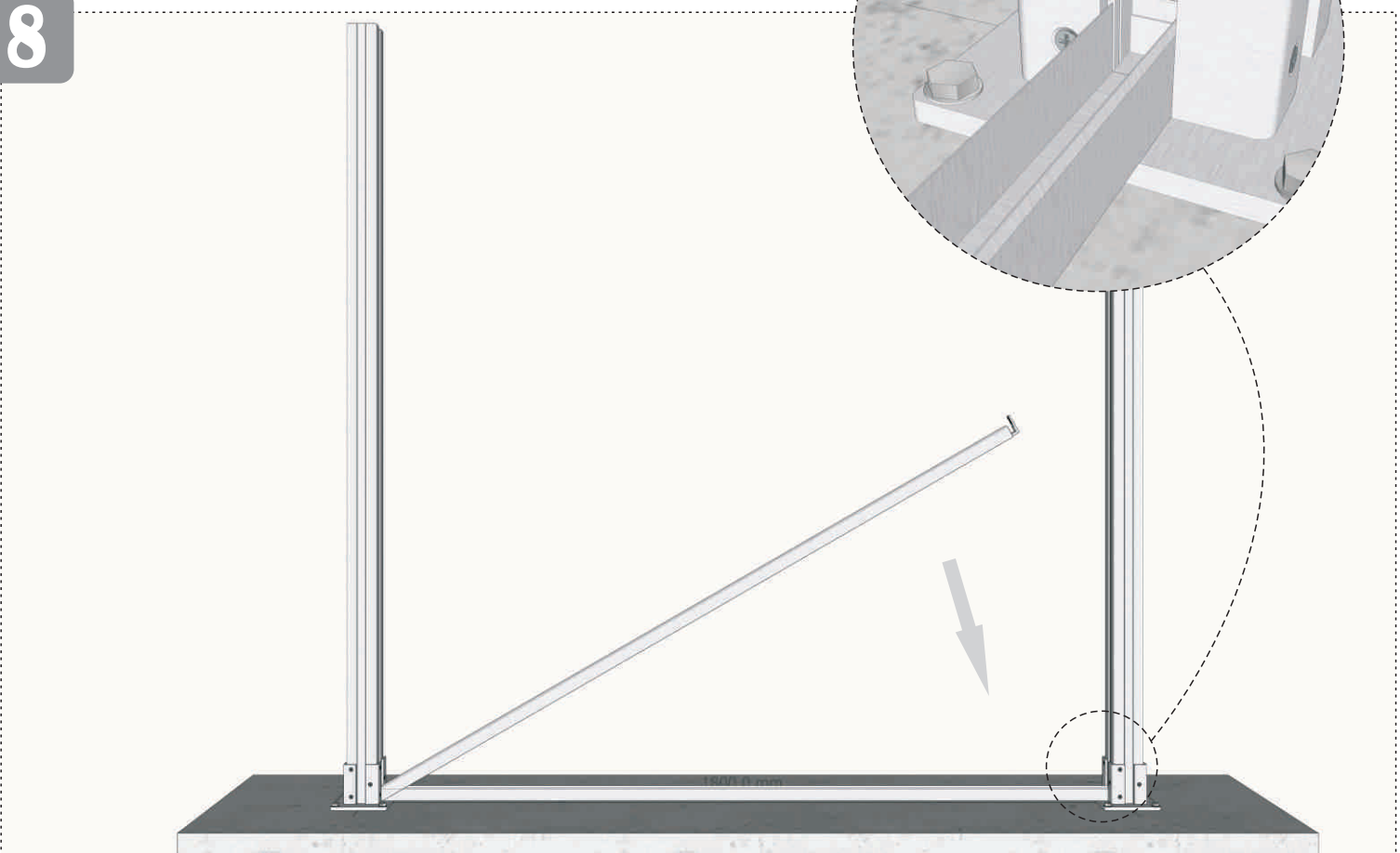

- Fix the bottom beam with a proper height above ground.

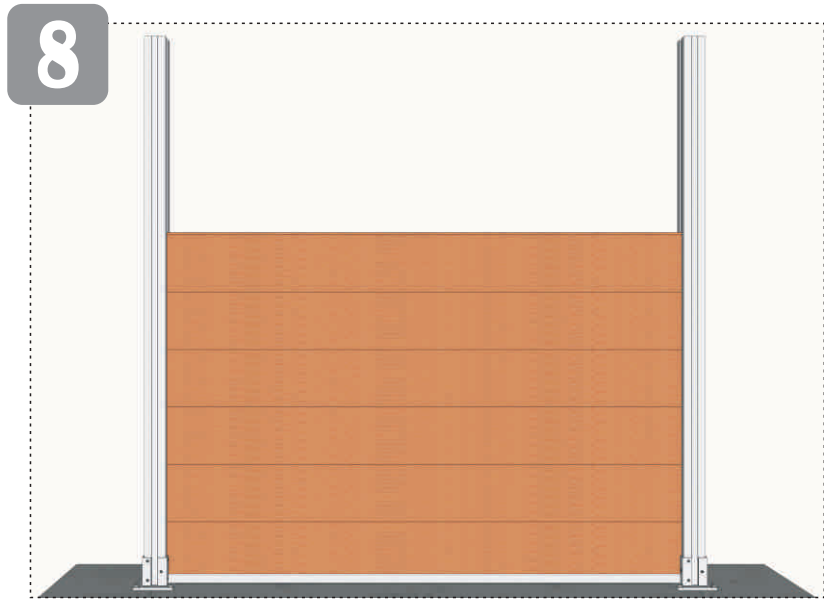
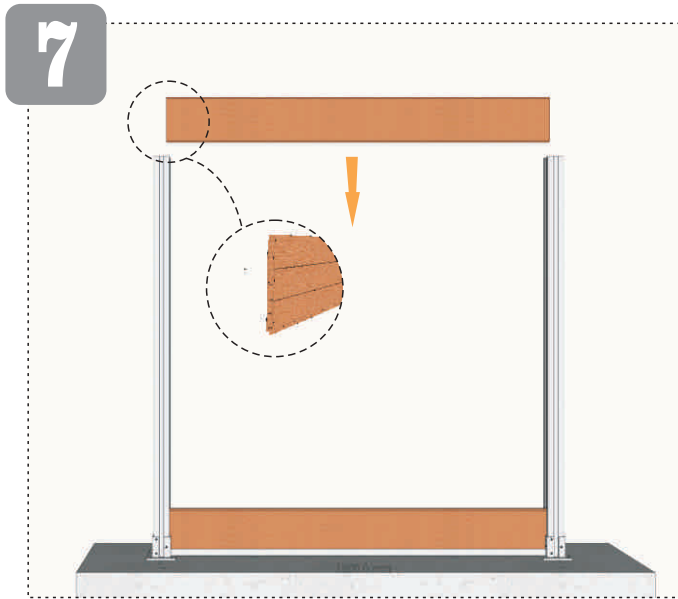

- Slide the composite fencing boards one by one. If you are going to make a half-private fencing, please reverse the Tongue and groove side of the fencing boards for installing the spacer.

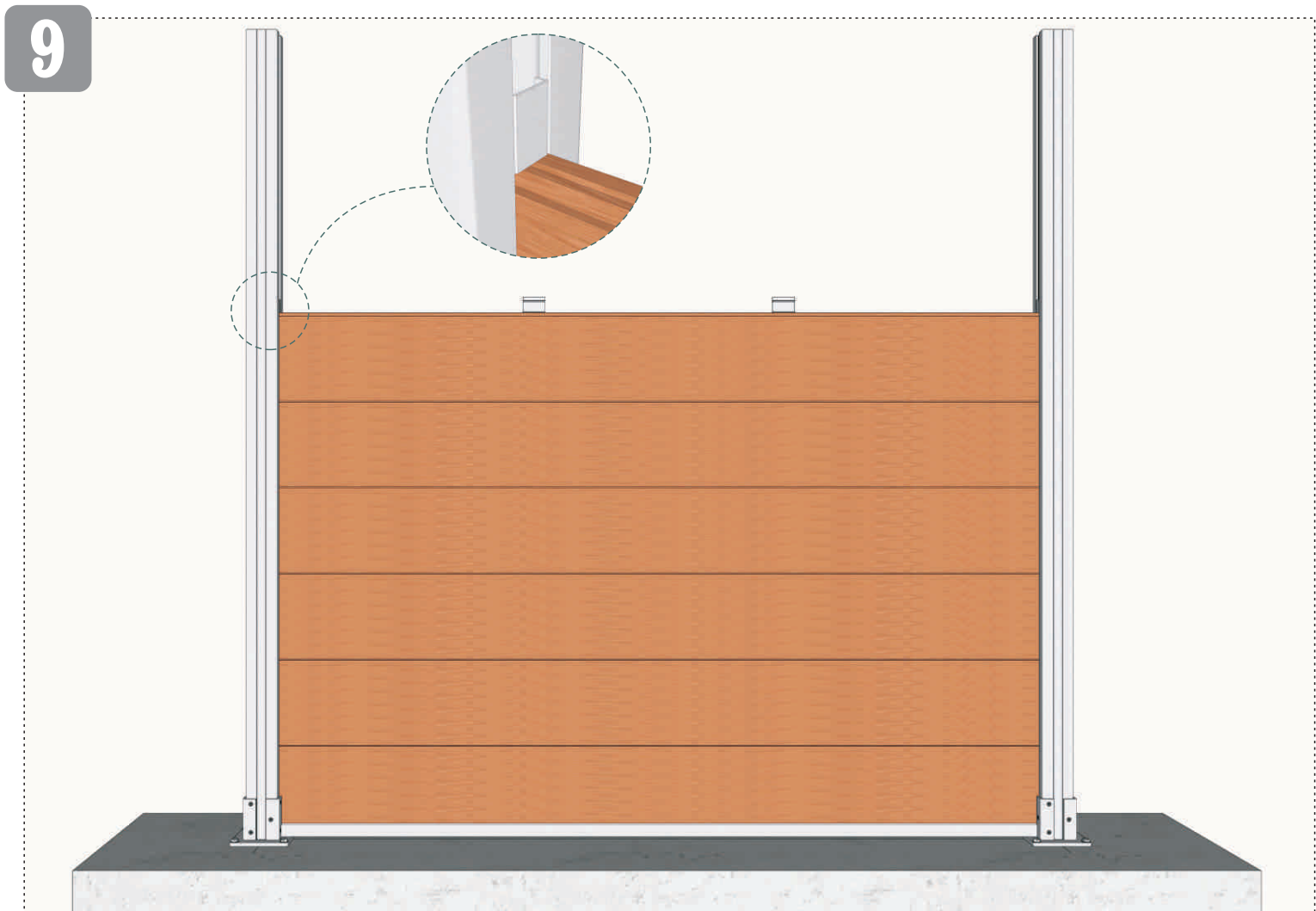

- Cut a 30mm post cover and slide it into the right place for support, insert the spacer in the middle.

10

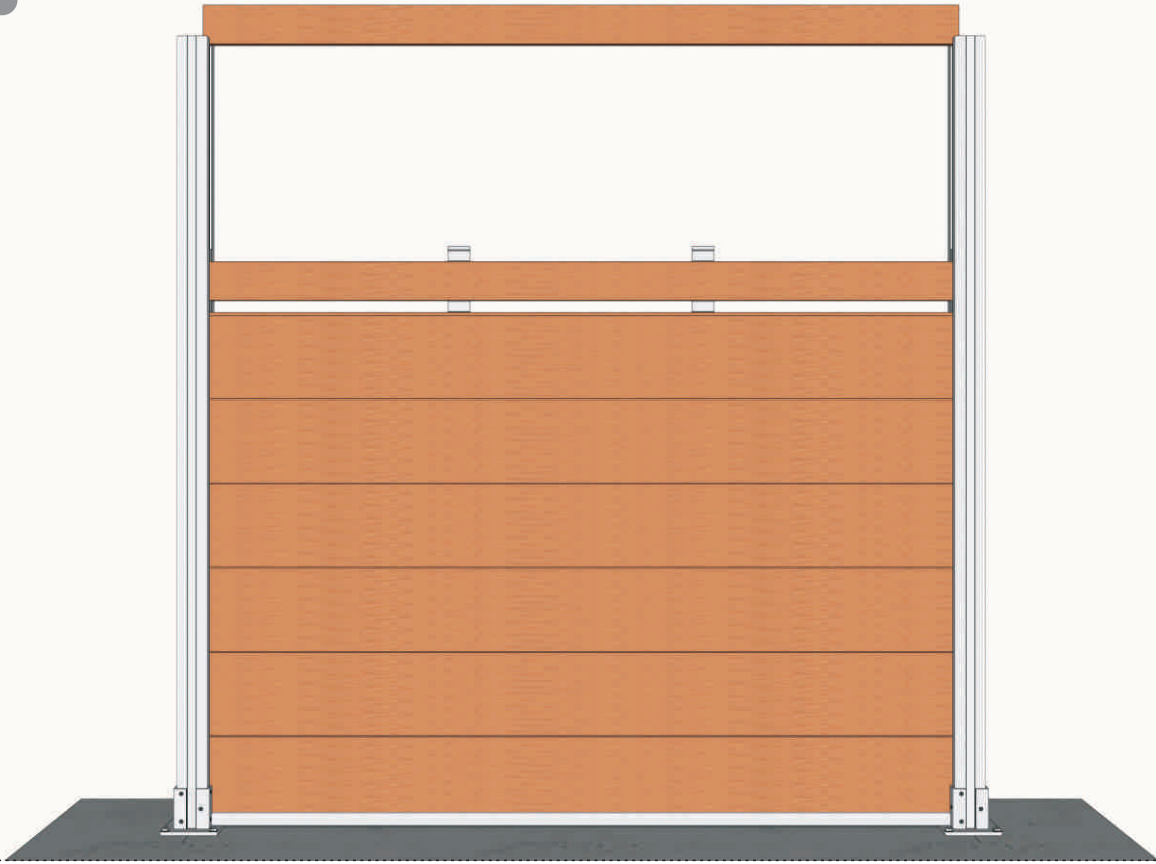

11



- Slide down less width fencing boards and repeat the steps.

12

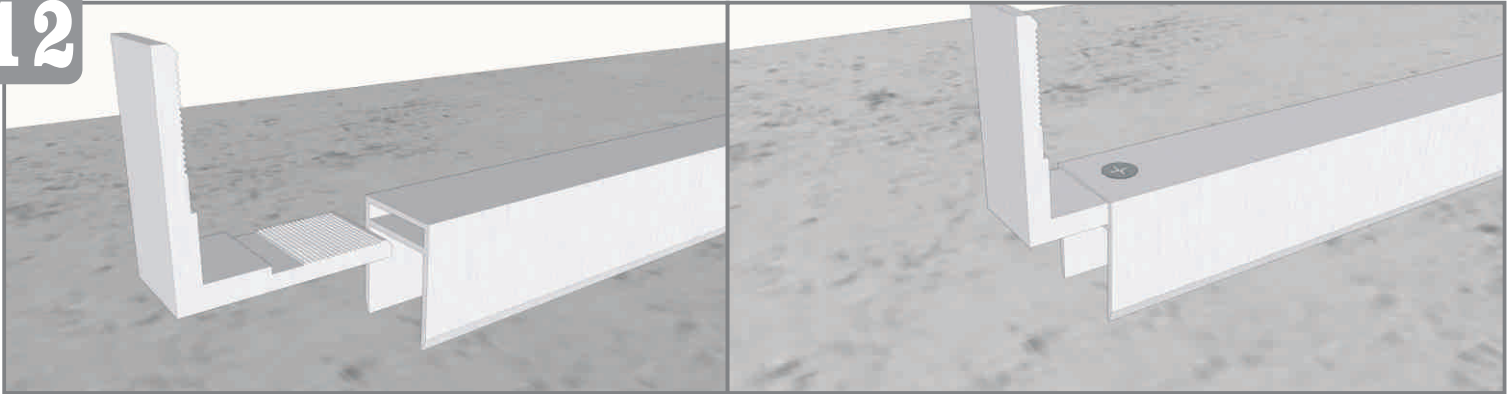

- Insert the angle bracket into the top beam as above picture showed and fixed it with screws.

13

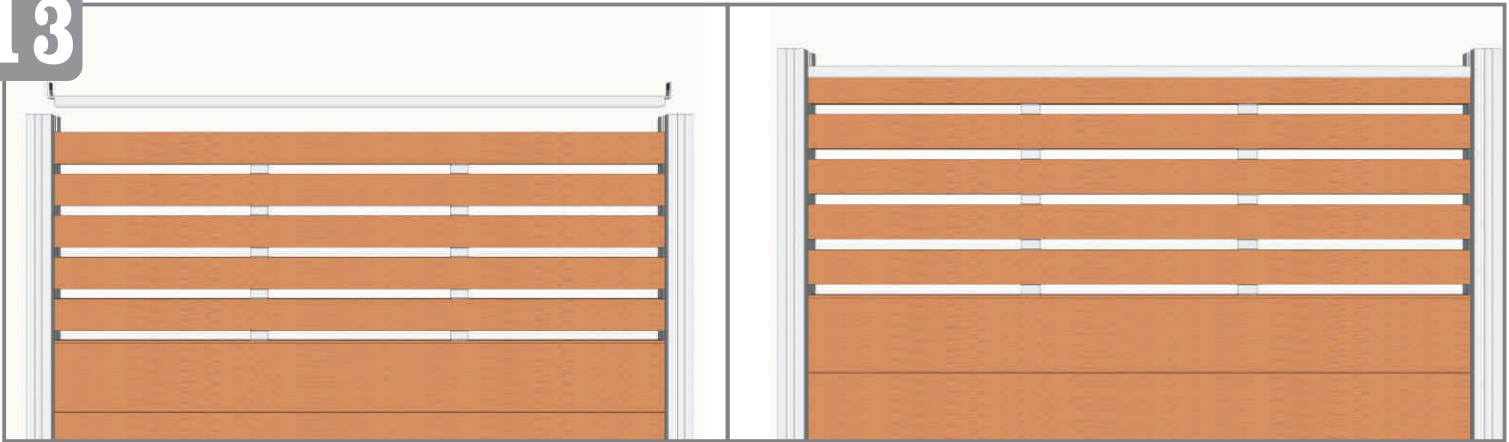

- Place the top beam

14

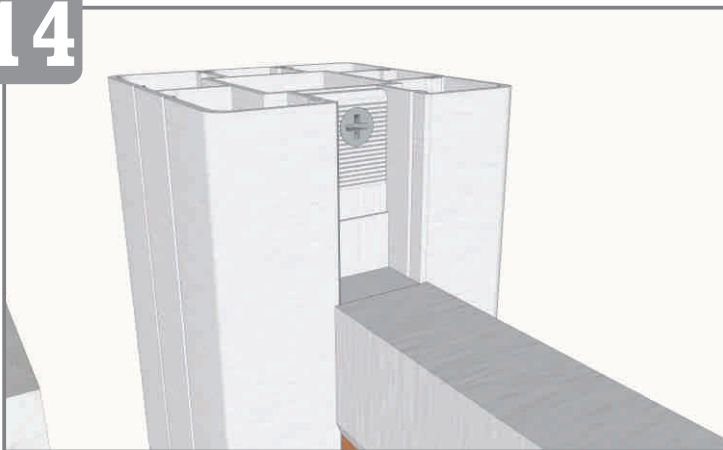

- Fix the bracket on the post

15

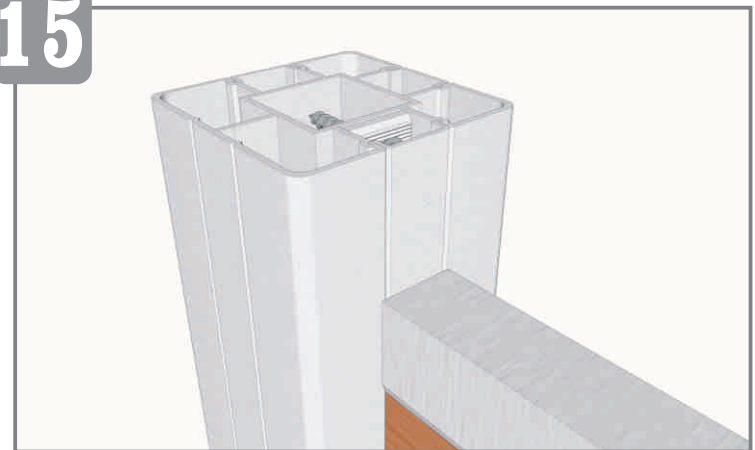

- Cut a proper length of post cover and slide it down to cover the bracket.

16

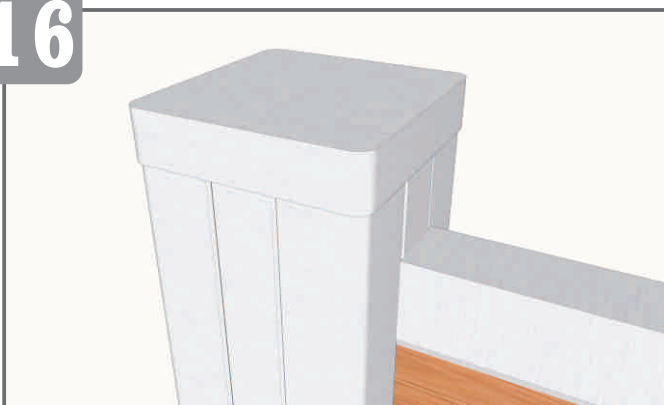

- Place the post caps and fix it with screws.